

# Bravo

MORE THAN A COMPLIMENT

WALL MOUNTED MINI SPLIT AIR CONDITIONING SYSTEM

## Installation Manual

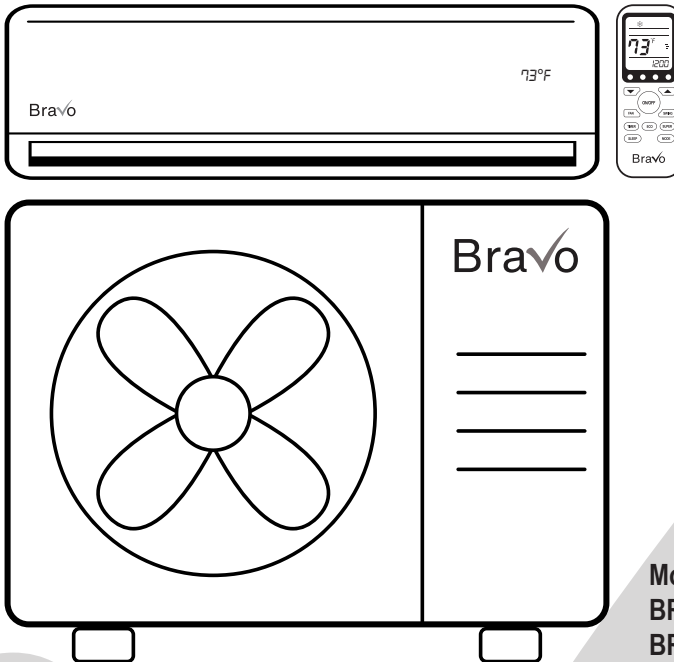

### Models:

BRV-12W-115VI

BRV-18W-230VI

BRV-24W-230VI

BRV-12LS-115VO

BRV-18LS-230VO

BRV-24LS-230VO

**BRAVO 28E REMOTE**

### IMPORTANT NOTE:

Thank you for purchasing our air conditioning system. Please read this manual carefully before operating your new air conditioning units. Make sure to save this manual for future reference.

# CONTENTS

---

SAFETY PRECAUTIONS .....	1
NAMES OF PARTS .....	4
INDOOR UNIT DISPLAY .....	5
EMERGENCY FUNCTION & AUTO-RESTART FUNCTION .....	6
REMOTE CONTROLLER .....	7
OPERATING INSTRUCTIONS .....	11
PROTECTION .....	16
INSTALLATION MANUAL.....	17
MAINTENANCE .....	26
TROUBLESHOOTING .....	27

In line with the company's policy of continual product improvement, the aesthetic and dimensional characteristics, technical data and accessories of this appliance may be changed without notice.

# SAFETY RULES AND RECOMMENDATIONS FOR THE INSTALLER

⚠ Read this guide before installing and using the appliance.

⚠ During the installation of the indoor and outdoor units the access to the working area should be forbidden to children. Unforeseeable accidents could happen.

⚠ Make sure that the base of the outdoor unit is firmly fixed.

⚠ Check that air cannot enter the refrigerant system and check for refrigerant leaks when moving the air conditioner.

⚠ Carry out a test cycle after installing the air conditioner and record the operating data.

⚠ The ratings of the fuse installed in the built-in control unit are T 5A / 250V.

⚠ The user must protect the indoor unit with a fuse of suitable capacity for the maximum input current or with another overload protection device.

⚠ Ensure that the mains voltage corresponds to that stamped on the rating plate. Keep the switch or power plug clean. Insert the power plug correctly and firmly into the socket, thereby avoiding the risk of electric shock or fire due to insufficient contact.

⚠ Check that the socket is suitable for the plug, otherwise have the socket changed.

⚠ The appliance must be fitted with means for disconnection from the supply mains having a contact separation in all poles that provide full disconnection under overvoltage category III conditions, and these means must be incorporated in the fixed wiring in accordance with the wiring rules.

⚠ The air conditioner must be installed by professional or qualified persons.

⚠ Do not install the appliance at a distance of less than 50 cm from inflammable substances (alcohol, etc.) Or from pressurised containers (e.g. spray cans).

⚠ If the appliance is used in areas without the possibility of ventilation, precautions must be taken to prevent any leaks of refrigerant gas from remaining in the environment and creating a danger of fire.

⚠ The packaging materials are recyclable and should be disposed of in the separate waste bins. Take the air conditioner at the end of its useful life to a special waste collection centre for disposal.

⚠ Only use the air conditioner as instructed in this booklet. These instructions are not intended to cover every possible condition and situation. As with any electrical household appliance, common sense and caution are therefore always recommended for installation, operation and maintenance.

⚠ The appliance must be installed in accordance with applicable national regulations.

⚠ Before accessing the terminals, all the power circuits must be disconnected from the power supply.

⚠ The appliance shall be installed in accordance with national wiring regulations.

⚠ This appliance can be used by children aged from 8 years and above and persons with reduced physical, sensory or mental capabilities or lack of experience and knowledge if they have been given supervision or instruction concerning use of the appliance in a safe way and understand the hazards involved. Children shall not play with the appliance. Cleaning and user maintenance shall not be made by children without supervision.

## SAFETY RULES AND RECOMMENDATIONS FOR THE USER

⚠ Do not try to install the conditioner alone; always contact specialized technical personnel.

⚠ Cleaning and maintenance must be carried out by specialised technical personnel. In any case disconnect the appliance from the mains electricity supply before carrying out any cleaning or maintenance.

⚠ Ensure that the mains voltage corresponds to that stamped on the rating plate. Keep the switch or power plug clean. Insert the power plug correctly and firmly into the socket, thereby avoiding the risk of electric shock or fire due to insufficient contact.

⚠ Do not pull out the plug to switch off the appliance when it is in operation, since this could create a spark and cause a fire, etc.

⚠ This appliance has been made for air conditioning domestic environments and must not be used for any other purpose, such as for drying clothes, cooling food, etc.

⚠ The packaging materials are recyclable and should be disposed of in the separate waste bins. Take the air conditioner at the end of its useful life to a special waste collection centre for disposal.

⚠ Always use the appliance with the air filter mounted. The use of the conditioner without air filter could cause an excessive accumulation of dust or waste on the inner parts of the device with possible subsequent failures.

⚠ The user is responsible for having the appliance installed by a qualified technician, who must check that it is earthed in accordance with current legislation and insert a thermomagnetic circuit breaker.

⚠ The batteries in remote controller must be recycled or disposed of properly.  
Disposal of Scrap Batteries --- Please discard the batteries as sorted municipal waste at the accessible collection point.

⚠ Never remain directly exposed to the flow of cold air for a long time. The direct and prolonged exposition to cold air could be dangerous for your health. Particular care should be taken in the rooms where there are children, old or sick people.

⚠ If the appliance gives off smoke or there is a smell of burning, immediately cut off the power supply and contact the Service Centre.

⚠ The prolonged use of the device in such conditions could cause fire or electrocution.

⚠ Have repairs carried out only by an authorised Service Centre of the manufacturer. Incorrect repair could expose the user to the risk of electric shock, etc.

⚠ Unhook the automatic switch if you foresee not to use the device for a long time. The airflow direction must be properly adjusted.

⚠ The flaps must be directed downwards in the heating mode and upwards in the cooling mode.

⚠ Only use the air conditioner as instructed in this booklet. These instructions are not intended to cover every possible condition and situation. As with any electrical household appliance, common sense and caution are therefore always recommended for installation, operation and maintenance.

⚠ Ensure that the appliance is disconnected from the power supply when it will remain inoperative for a long period and before carrying out any cleaning or maintenance.

⚠ Selecting the most suitable temperature can prevent damage to the appliance.

## SAFETY RULES AND PROHIBITIONS

- ⊖ Do not bend , tug or compress the power cord since this could damage it. Electrical shocks or fire are probably due to a damaged power cord. Specialised technical personnel only must replace a damaged power cord.
  - ⊖ Do not use extensions or gang modules.
  - ⊖ Do not touch the appliance when barefoot or parts of the body are wet or damp.
  - ⊖ Do not obstruct the air inlet or outlet of the indoor or the outdoor unit.  
The obstruction of these openings causes a reduction in the operative efficiency of the conditioner with possible consequent failures or damages.
  - ⊖ In no way alter the characteristics of the appliance.
  - ⊖ Do not install the appliance in environments where the air could contain gas , oil or sulphur or near sources of heat.
  - ⊖ This appliance is not intended for use by persons (including children ) with reduced physical, sensory or mental capabilities, or lack of experience and knowledge, unless they have been given supervision or instruction concerning use of the appliance by a person responsible for their safety.
- ⊖ Do not climb onto or place any heavy or hot objects on top of the appliance.
  - ⊖ Do not leave windows or doors open for long when the air conditioner is operating.
  - ⊖ Do not direct the airflow onto plants or animals.
  - ⊖ A long direct exposition to the flow of cold air of the conditioner could have negative effects on plants and animals.
  - ⊖ Do not put the conditioner in contact with water.  
The electrical insulation could be damaged and thus causing electrocution.
  - ⊖ Do not climb onto or place any objects on the outdoor unit
  - ⊖ Never insert a stick or similar object into the appliance. It could cause injury.
  - ⊖ Children should be supervised to ensure that they do not play with the appliance. If the supply cord is damaged, it must be replaced by the manufacturer, its service agent or similarly qualified persons in order to avoid a hazard.

# NAMES OF PARTS

## INDOOR UNIT

No.	Description
1	Front panel
2	Air filter
3	Optional filter (if installed)
4	LED Display
5	Signal receiver
6	Terminal block cover
7	Ionizer generator(if installed)
8	Deflectors
9	Emergency button
10	Indoor unit rating label (Stick position optional)
11	Airflow direction louver
12	Remote controller

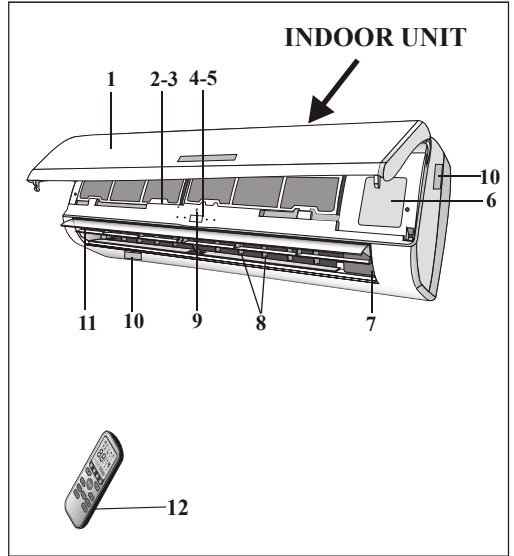

## OUTDOOR UNIT

No.	Description
13	Air outlet grille
14	Outdoor unit rating label
15	Terminal block cover
16	gas valve
17	liquid valve

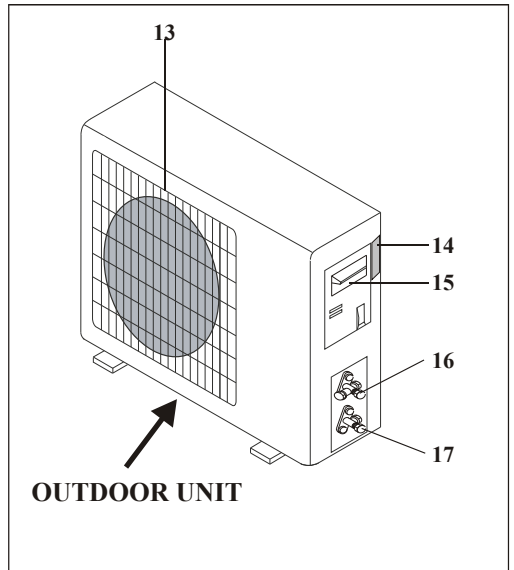

*Note: the above figures are only intended to be a simple diagram of the appliance and may not correspond to the appearance of the units that have been purchased.*

# INDOOR UNIT DISPLAY

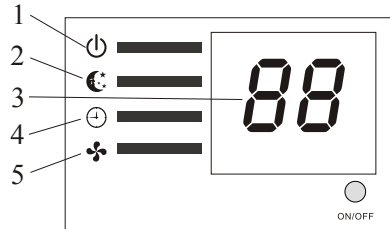
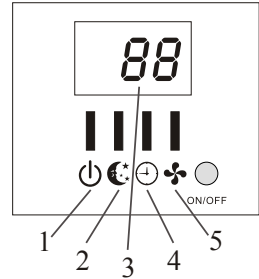
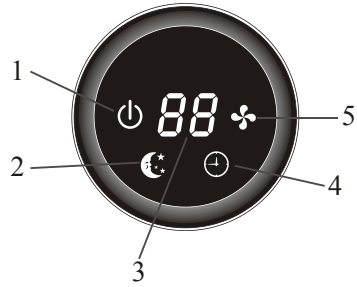
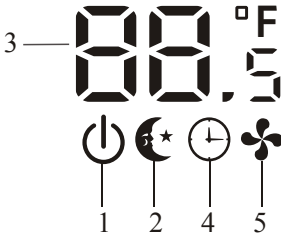
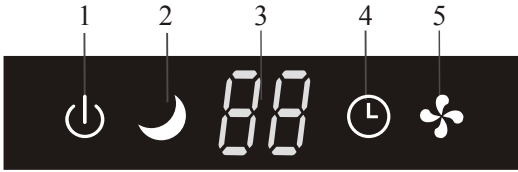
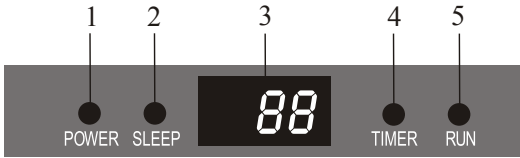

No.	Led		Function
1	POWER	⏻	This symbol appears when the unit is power on
2	SLEEP	🌙	SLEEP mode
3	Temperature display (if present) /Error code	88	(1) Lights up during Timer operation when the air conditioner is operational (2)Displays the malfunction code when fault occurs.
4	TIMER	🕒	Lights up during Timer operation.
5	RUN	🌀	The symbol appears when the unit is turned on, and disappear when the unit is turned off.

⚠️ The shape and position of switches and indicators may be different according to the model, but their function is the same.

# EMERGENCY FUNCTION & AUTO-RESTART FUNCTION

## AUTO-RESTART FUNCTION

The appliance is preset auto - restart function by manufacturer. In case of a sudden power failure, the module memorizes the setting conditions before the power failure. when the power restores, the unit restarts automatically with all the previous settings preserved by the memory function.

To deactivate the AUTO-RESTART function, proceed as follows:

1. Switch the air conditioner off and plug it off.
  2. Press the emergency button meanwhile plug it in.
  3. Keep pressing the emergency button for more than 10 seconds until you hear four short beeps from the unit. The AUTO-RESTART function is deactivate.
- To activate the AUTO - RESTART function, follow the same procedure until you hear three short beeps from the unit.

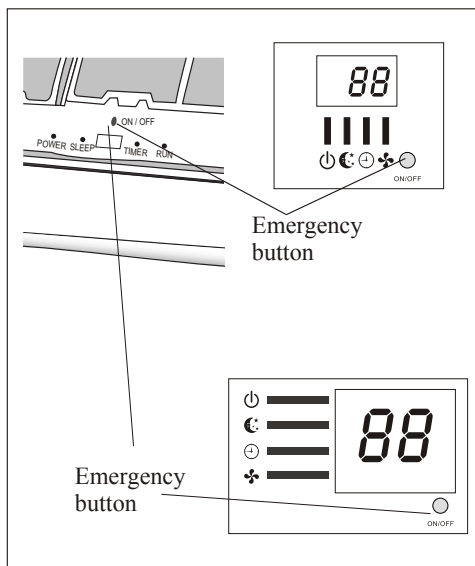

## EMERGENCY FUNCTION

If the remote controller fails to work or maintenance necessary, proceed as follows:

Open and lift the front panel up to an angle to reach the emergency button.

1. One press of the emergency button (one beep) will lead to the forced COOLING operation
2. Two press of the emergency button within 3 sec (two beeps) will lead to the forced HEATING operation.
3. To switch off the unit, you just need to press the button again (a single long beep).
4. After 30 minutes in forced operation, the air conditioner will automatically start working in 73°F cooling mode, auto fan speed.

\* The FEEL function is described in page 15.

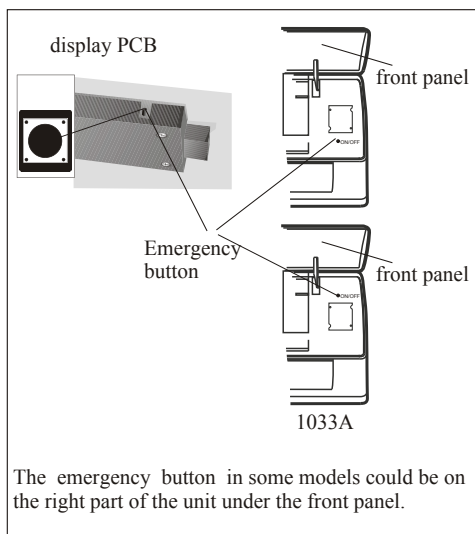

 The shape and position of the emergency button may be different according to the model, but their function is the same.

Remark: the external static pressure of heat pumps is 0 Pa for all models.



# REMOTE CONTROLLER

No.	Button	Function
1	▲ (TEMP UP)	Press it to increase temperature / time setting.
2	▼ (TEMP DN)	Press it to decrease temperature/ time setting.
3	ON/OFF	Press it to start or stop operation.
4	FAN	To select the fan speed of auto/low/mid/high
5	TIMER	Press it to set auto-off timer.
6	SLEEP	To activate the function "SLEEP"
7	ECO	In cooling mode, press this button, the temperature will increase 2 °F on the base of setting temperature In heating mode, press this button, the temperature will decrease 2 °F on the base of setting temperature
8	MODE	To select the mode of operation
9	SUPER or TURBO	Press this button to activate / deactivate the Super function which enables the unit to reach the preset temperature in the shortest time. In COOL mode, the unit will give the maximum cooling temperature with 60 °F, high fan speed. In HEAT mode, the unit will give the maximum heating temperature with 87.8 °F, high fan speed.
10	SWING	To activate or deactivate of the movement of the deflectors.
11	CLOCK	When you press this button, the time will be flickering; then through "▲" and "▼", you can adjust the time (one time you press, one minute you adjust; and if you continue to press, the time change rapidly), after adjusting to your required time, please press this button again to fix the time.
12	DISPLAY	To switch on/off the LED display
13	HEALTHY	To switch - on /off HEALTHY function. It is a button which controls the ionizer or plasma generator for available model only.
14	3D	When you press "3D", the horizontal and vertical vanes will swing together at the same time.
15	RESET	To restart REMOTE CONTROLLER
16	ANTI-MILDEW or Mute	To activate the function ANTI-MILDEW or To activate the function of Mute

⚠ The out looking and some function of remote controller maybe difference.

⚠ The shape and position of buttons and indicators maybe difference according to the model, but their function is the same.

⚠ The unit confirms the correct reception of each press button with a beep.

# REMOTE CONTROLLER

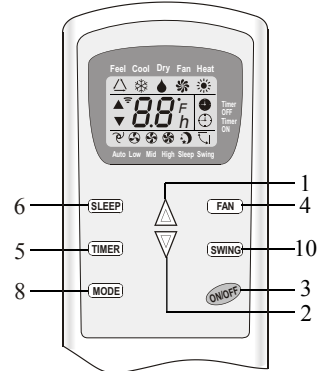
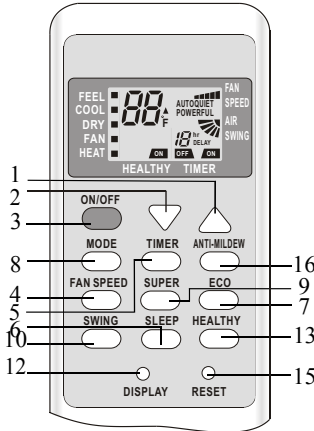
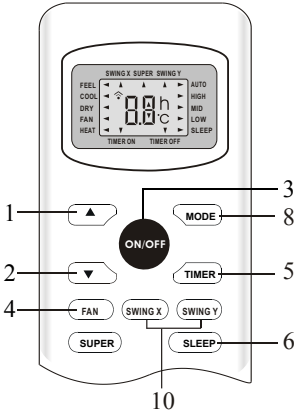
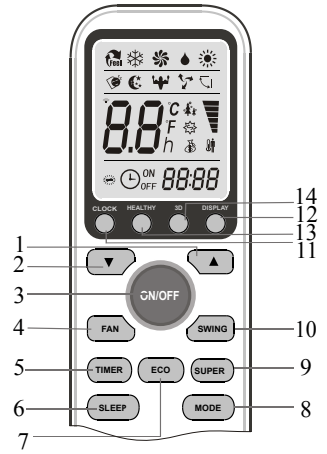
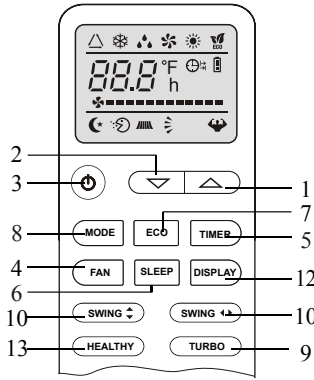
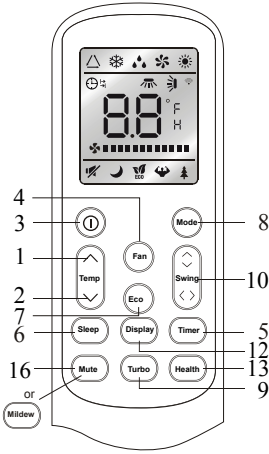

































































⚠ The out looking and some function of remote controller maybe difference.

⚠ The shape and position of buttons and indicators maybe difference according to the model, but their function is the same.

# REMOTE CONTROLLER

## Remote controller DISPLAY

### Meaning of symbols on the liquid crystal display

No.	Symbols	Meaning
1	 or 	FEEL mode indicator
2		COOLING indicator
3	 or 	DEHUMIDIFYING indicator
4		FAN ONLY OPERATION indicator
5		HEATING indicator
6	 or 	SIGNAL RECEPTION indicator
7	 or  or  or  or 	TIMER OFF indicator
8	 or  or  or  or 	TIMER ON indicator
9	 or  or  or  or 	AUTO FAN indicator
10	 or  or  or  or 	LOW FAN SPEED indicator
11	 or  or  or  or 	MIDDLE FAN SPEED indicator
12	 or  or  or  or 	HIGH FAN SPEED indicator
13	 or  or  or 	SLEEP indicator
14		COMFORTABLE SLEEP indicator (optional)
15		FEEL indicator(optional)
16	 or  or  or  or 	FLAP SWING indicator
17		FLAP and Deflectors SWING indicator
18	 or  or 	SUPER indicator
19	 or  or 	HEALTHY indicator
20	 or  or 	ECO indicator
21		ANTI-MILDEW indicator
22	 or 	BATTERY indicator
23		CLOCK indicator
24		Mute indicator

# REMOTE CONTROLLER

## Replacement of Batteries

Remove the battery cover plate from the rear of the remote controller, by sliding it in the direction of the arrow.

Install the batteries according the direction (+and -)shown on the Remote Controller.

Reinstall the battery cover by sliding it into place.

⚠ Use 2 LRO 3 AAA (1.5V) batteries . Do not use rechargeable batteries . Replace the old batteries with new ones of the same type when the display is no longer legible.

Do not dispose batteries as unsorted municipal waste. Collection of such waste separately for special treatment is necessary.

⚠ Refer to picture 1:

i. When you open the battery cover, you can see a DIP switch on the cover back.l

DIP switch on position	Function
°C	The remote controller is adjusted in degree celsius
°F	The remote controller is adjusted in degree fahrenheit.
Cool	The remote controller is adjusted in only cooling mode
Heat	The remote controller is adjusted in cooling and heating mode

ii. NOTE:After adjusting the function, you need to take out the batteries and repeat the procedure described above.

⚠ Refer to picture 2:

When you insert the batteries for the first time in the remote controller or if you change them, you need to program the remote controller of only cooling or cooling and heating.

When you insert the batteries, the symbols ❄ (COOL ■) and ☀ (HEAT ■) start flashing. If you push whatever button when the symbol ❄ (COOL ■) is displayed, the remote controller is adjusted in only cooling mode . If you push whatever button when the symbol ☀ (HEAT ■) is displayed , the remote controller is adjusted in Cooling and heating mode.

⚠ NOTE:if you adjust the remote controller in cooling mode, it will not be possible to activate the heating function in units with heating pump . you need to take out the batteries and repeat the procedure described above.

- ⚠
1. Direct the remote controller toward the Air conditioner.
  2. Check that there are no objects between the remote control and the Signal receptor in the indoor unit.
  3. Never leave the remote controller exposed to the rays of the sun
  4. Keep the remote controller at a distance of at least 1m from the television or other electrical appliances.

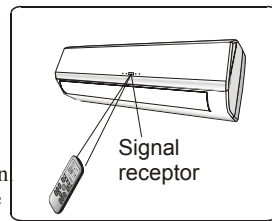
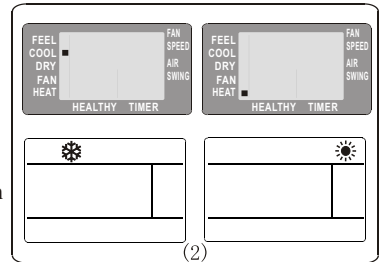
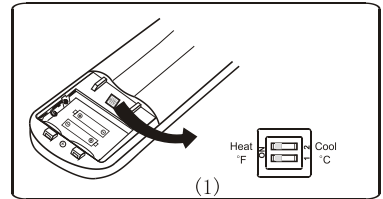
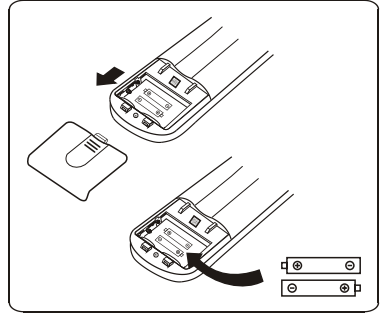

Recommendations for locating and using the remote controller holder (if present)

The remote controller be kept in a wall-mounted holder

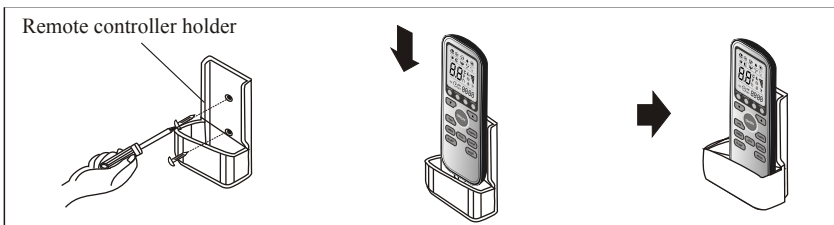

# OPERATING INSTRUCTIONS

The air sucked by the fan enters from the grill and passes through the filter, then it is cooled/dehumidified or heated through the heat exchanger.

The direction of the air outlet is motorized up and down by flaps, and manually moved right and left by the vertical deflectors, for some models, the vertical deflectors could be controlled by motor as well.

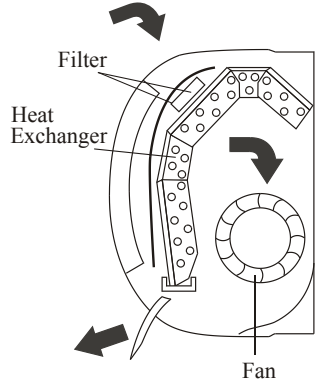

## “SWING” CONTROL OF THE AIR FLOW



- The air outlet flow is uniformly distributed in the room.
- It is possible to position the direction of the air in the optimal.

The key **SWING** or **SWING** activates the “FLAP”, the air flow is directed alternatively from up to down. In order to guarantee an even diffusion of the air in the room.

The key **SWING** activates the motorized “deflectors”, the air flow is directed alternatively from left to right. (Optional function, depends on the models)

- In cooling mode, orient the flaps in horizontal direction;
- In heating mode, orient the flaps downward as the warm air tends to rise.

The deflectors are positioned manually and placed under the flaps. They allow to direct the air flow rightward or leftward.

**⚠** This adjustment must be done while the appliance is switched off.

**⚠** Never position “Flaps” manually, the delicate mechanism might seriously damaged!

**⚠** Never poke fingers, sticks or other objects in the air inlet or outlet vents. Such accidental contact with live parts might cause unforeseeable damage or hurt.

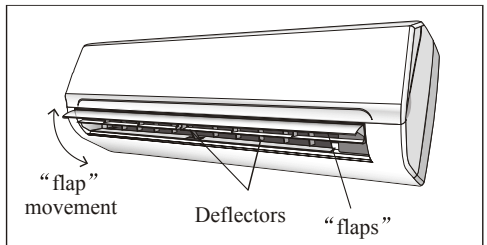
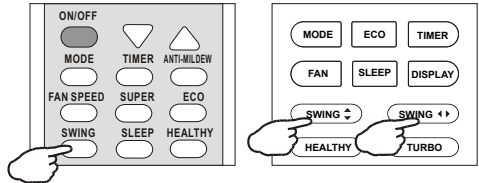
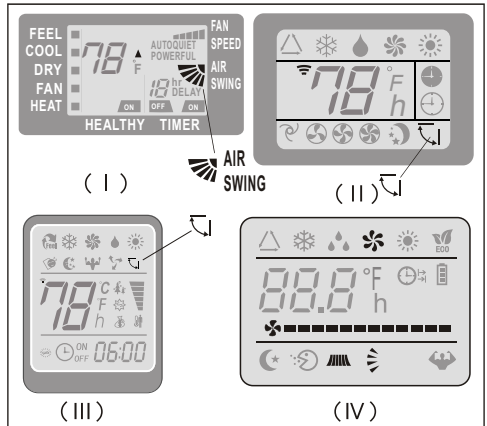

# OPERATING INSTRUCTIONS

## COOLING MODE

**COOL ■** The cooling function allows the air conditioner to cool the room and at the same time reduces Air humidity.

To activate the cooling function ( COOL ), press the **MODE** button until the symbol ❄️ ( COOL ■ ) appears on the display.

The cooling function is activated by setting the button ▲ or ▼ at a temperature lower than that of the room.

To optimize the function of the Air conditioner, adjust the temperature ( 1 ), the speed ( 2 ) and the direction of the air flow ( 3 ) by pressing the button indicated.

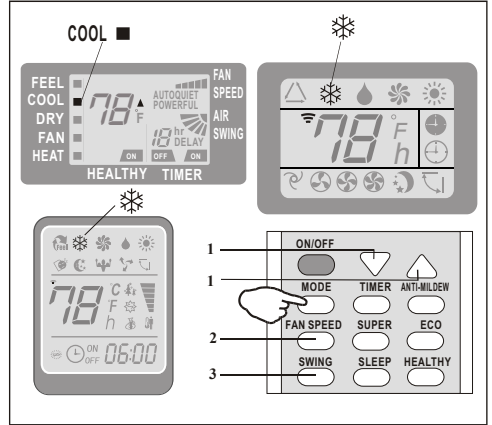

## HEATING MODE

**HEAT ■** The heating function allows the air conditioner to heat the room.

To activate the heating function ( HEAT ), press the **MODE** button until the symbol ☀️ ( HEAT ■ ) appears on the display.

With the button ▲ or ▼ set a temperature higher than that of the room..

To optimize the function of the Air conditioner adjust the temperature ( 1 ), the speed ( 2 ) and the direction of the air flow ( 3 ) by pressing the button indicated

⚠️ If the appliance is fitted with a electrical heater, which delays appliance to startup in a few seconds to ensure an immediate output of hot air (Optional, depends on the model).

⚠️ In HEATING operation, the appliance can automatically activate a defrost cycle, which is essential to clean the frost on the condenser so as to recover its heat exchange function. This procedure usually lasts for 2-10 minutes during defrosting, indoor unit fan stop operation. After defrosting, it resumes to HEATING mode automatically.

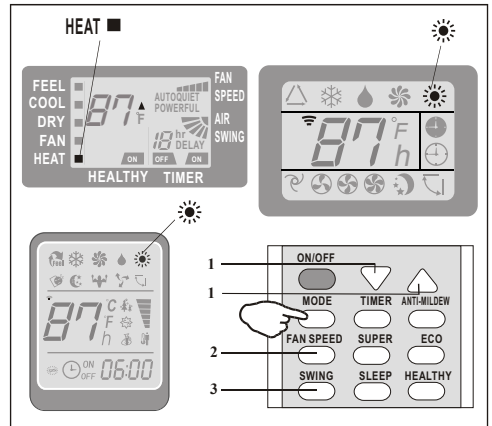

# OPERATING INSTRUCTIONS

## TIMER MODE----TIMER ON

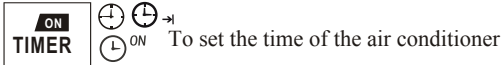

To program the automatical switching-on time, the appliance should be power off.

Press **TIMER** at the first time , set the temperature with pressing the button **▲** or **▼**;

Press **TIMER** at the second time , set the rest time with pressing the button **▲** or **▼**;

Press **TIMER** at the third time, confirm the setting, then the rest time to next automatical switching-on could be read on the display.

### NOTE !

Before proceeding with the time: program the working mode with the button **MODE** (2) and the fan speed with the button **FAN** (3) . Switch the conditioner off (with the key **ON/OFF** ) .

Note:To cancel the setted function ,press the **TIMER** button again.

Note:In case of power off,it is necessary to set **TIMER ON** again

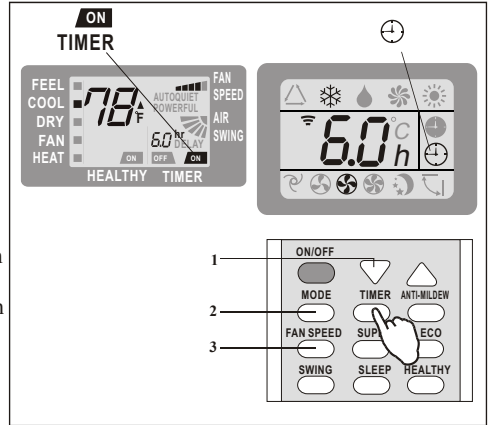

Indoor display

## TIMER MODE----TIMER OFF

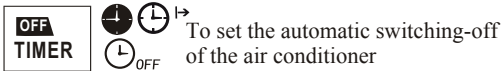

The timed stop is programmed by pressing **TIMER** , Set the rest time by pressing the button **▲** or **▼**,until the rest time displayed is to your demand then press **TIMER** again.

Note:To cancel the setted function, press the **TIMER** button again.

Note:In case of power off,it is necessary to set **TIMER OFF** again

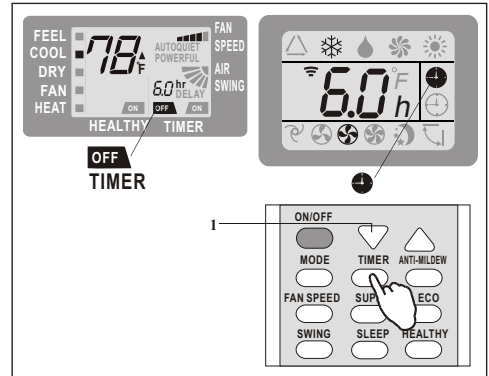

Indoor display

⚠ Note: The **TIMER** function can be set at half-hour intervals.

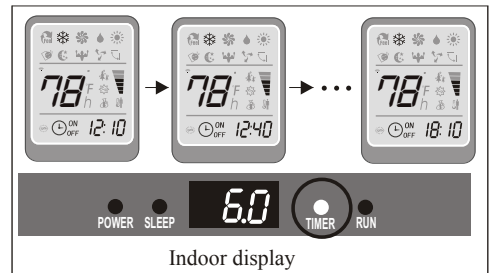

Indoor display

# OPERATING INSTRUCTIONS

## FAN MODE

FAN ■ 

The conditioner works in only ventilation.

To set the FAN mode, Press **MODE** until  ( FAN ■ ) appears in the display.

With pressing **FAN** button the speed changes in the following sequence: LOW/ MEDIUM/HIGH /AUTO in FAN mode.

The remote control also stores the speed that was set in the previous mode of operation.

In FEEL mode (automatic) the air conditioner automatically chooses the fan speed and the mode of operation (COOLING or HEATING).

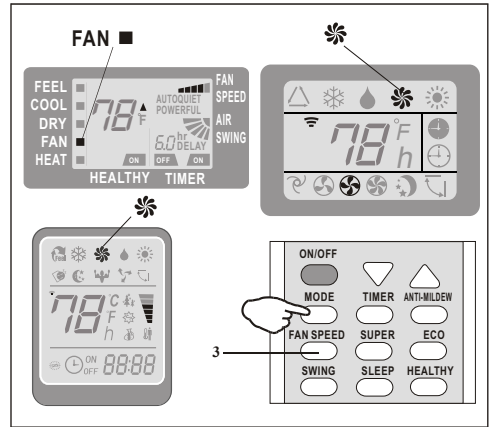

## DRY MODE

DRY ■ 

This function reduces the humidity of the air to make the room more comfortable.

To set the DRY mode, Press **MODE** until  ( DRY ■ ) appears in the display. An automatic function of alternating cooling cycles and air fan is activated.

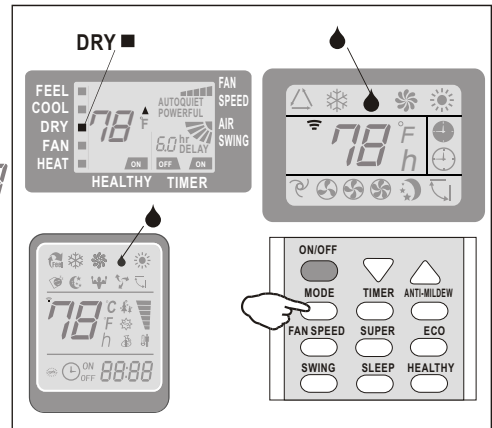



# OPERATING INSTRUCTIONS

## FEEL MODE



Automatic mode.

To activate the FEEL (automatic) mode of operation, press the [MODE] button on the remote controller until the symbol  $\triangle$  (FEEL  $\blacksquare$ ) appears on the display.

In FEEL mode the fan speed and the temperature are set automatically according to the room temperature (tested by the temperature sensor which is incorporated in the indoor unit).

Ambient temp	Operation mode	Auto temp.
< 68°F	HEATING (FOR HEAT PUMP TYPE) FAN (FOR COOL ONLY TYPE)	73°F
68°F~79°F	DRY	64°F
> 79°F	COOL	73°F

To optimize the function of the air conditioner, adjust the temperature (only  $\pm 2^\circ\text{F}$ ) (1), the speed (2) and the direction of the air flow (3) by pressing the buttons indicated

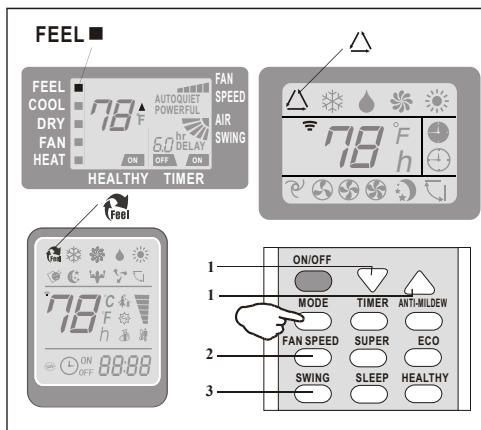

## SLEEP MODE



To activate the SLEEP mode of operation, press the [SLEEP] button on the remote controller until the symbol  $\text{☾}$  (AUTOQUIET) appears on the display.

The function “SLEEP” automatically adjusts the temperature to make the room more comfortable during the night. In cooling or dry mode, the set temperature will automatically raise by  $1^\circ\text{F}$  every 60 minutes, to achieve a total rise of  $2^\circ\text{F}$  during the first 2 hours of operation.

In heating mode the set temperature is gradually decreased by  $2^\circ\text{F}$  during the first 2 hours of operation.

After 10 hours running in sleep mode, the air conditioner will change to the previous setting mode.

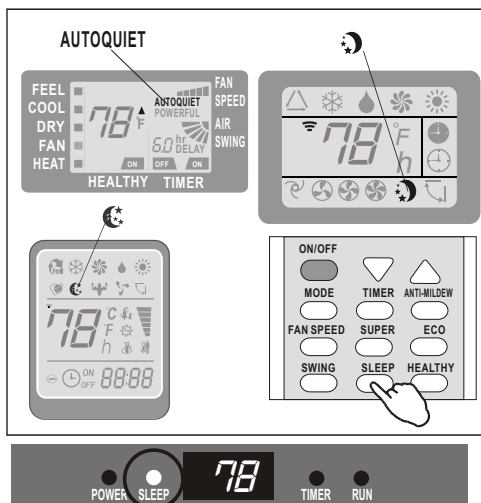

Indoor display

# PROTECTION

The air conditioner is programmed for comfortable and suitable living conditions, if it is used in abnormal conditions as below, certain safety protection features might come into effect.

## For T1 Climate condition models:

No.	MODE	Ambient temperature
1	Heating	Outdoor temperature is over 75°F
		Outdoor temperature is below 18°F
		Room temperature is over 80°F
2	Cooling	Outdoor temperature is over 109°F
		Room temperature is below 69°F
3	Dry	Room temperature is below 64°F

## For Tropical (T3) Climate condition models:

No.	MODE	Ambient temperature
1	Heating	Outdoor temperature is over 75°F
		Outdoor temperature is below 19°F
		Room temperature is over 80°F
2	Cooling	Outdoor temperature is over 125°F
		Room temperature is below 69°F
3	Dry	Room temperature is below 64°F

 The unit does not operate immediately if it is turned on after being turned off or after changing the mode during operation. this is a normal self-protection action, you need wait for about 3 minutes.

 The capacity and efficiency are according to the test conducted at full-load operation\*.  
\*The highest speed of indoor fan motor and the maximum open angle of the flaps and deflectors are requested.

# INSTALLATION MANUAL---Selecting the Installation Place

## INDOOR UNIT

- Install the indoor unit on a strong wall that is not subject to vibrations.
- The in let and outlet ports should not be obstructed:the air should be able to blow all over the room.
- Do not install the unit near a source of heat , steam,or flammable gas.
- Install the unit near an electric socket or private circuit.
- Do not install the unit where it will be exposed to direct sunlight.
- Select a site where the condensed water can be easily drained out, and where it is easily connected to outdoor unit.
- Check the machine operation regularly and reserve the necessary spaces as shown in the picture.
- Select a place where the filter can be easily taken out.

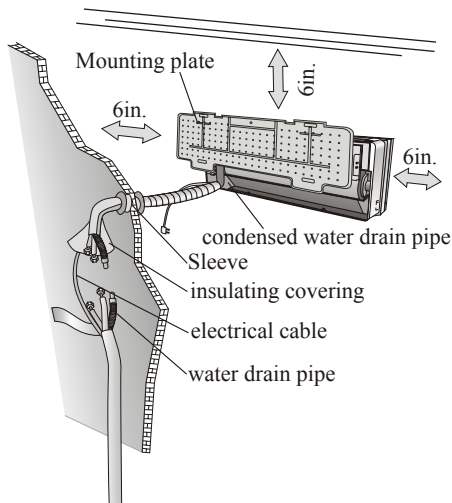

## OUTDOOR UNIT

- Do not install the outdoor unit near sources of heat, steam or flammable gas.
- Do not install the unit in too windy or dusty places.
- Do not install the unit where people often pass. Select a place where the air discharge and operating sound will not disturb the neighbours.
- Avoid installing the unit where it will be exposed to direct sunlight ( other wise use a protection , if necessary, that should not interfere with the air flow).
- Reserve the spaces as shown in the picture for the air to circulate freely.
- Install the outdoor unit in a safe and solid place.
- If the outdoor unit is subject to vibration, place rubber gaskets onto the feet of the unit..

minimum space to be reserved (in.) showing in the picture

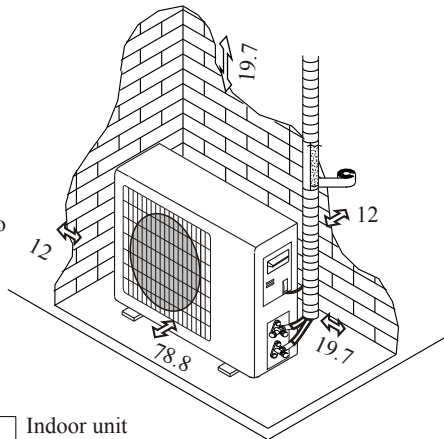

### Installation Diagram

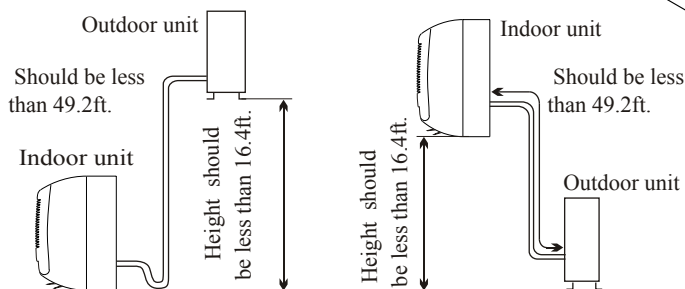

The purchaser must ensure that the person and/or company who is to install, maintain or repair this air conditioner has qualifications and experience in refrigerant products.

# INSTALLATION MANUAL---Installation of the Indoor unit

Before starting installation, decide on the position of the indoor and outdoor units, taking into account the minimum space reserved around the units

⚠ Do not install your air conditioner in a wet room such as a bathroom or laundry etc

⚠ The installation site should be 8.2ft. or more above the floor.

**To install, proceed as follows:**

## Installation of the mounting plate

- 1 Always mount the rear panel horizontally and vertically
2. Drill 1.25in. deep holes in the wall to fix the plate;
3. Insert the plastic anchors into the hole;
4. Fix the rear panel on the wall with provided tapping screws
5. Be sure that the rear panel has been fixed firmly enough to withstand the weight

*Note : The shape of the mounting plate may be different from the one above, but installation method is similar .*

## Drilling a hole in the wall for the piping

1. Make the piping hole 2 in. in diameter in the wall at a slight downward slant to the outdoor side.
2. Insert the piping-hole sleeve into the hole to prevent the connection piping and wiring from being damaged when passing through the hole.

⚠ The hole must slope downwards towards the exterior

*Note : Keep the drain pipe down towards the direction of the wall hole, otherwise leakage may occur.*

## Electrical connections---Indoor unit

1. Open the front panel.
2. Take off the cover as indicated in the picture ( by removing a screw or breaking the hooks).
3. For the electrical connections, see the circuit diagram on the right part of the unit under the front panel.
4. Connect the cable wires to the screw terminals by following the numbering .Use wire size suitable to the electric power input (see name plate on the unit) and according to all current national safety code requirements.

⚠ The cable connecting the outdoor and indoor units must be suitable for outdoor use.

⚠ The plug must be accessible also after the appliance has been installed so that it can be pulled out if necessary.

⚠ An efficient earth connection must be ensured.

⚠ If the power cable is damaged, it must be replaced by an authorised Service Centre.

*Note: Optional the wires can be connected to the main PCB of indoor unit by manufacturer according to the model without terminal block.*

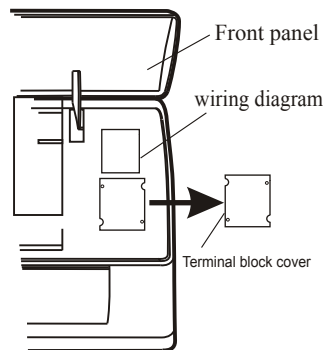
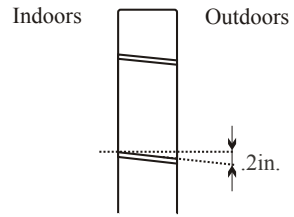
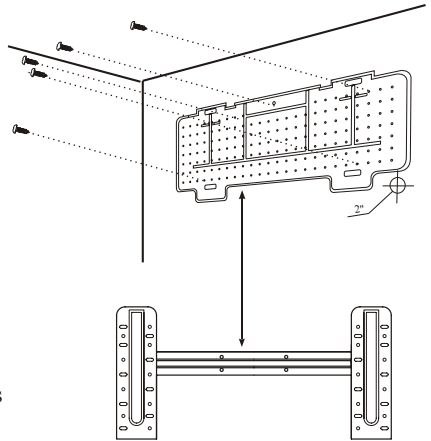

# INSTALLATION MANUAL---Installation of the Indoor unit

## Refrigerant piping connection

The piping can be run in the 3 directions indicated by numbers in the picture . When the piping is run in direction 1 or 3, cut a notch along the groove on the side of the indoor unit with a cutter.

Run the piping in the direction of the wall hole and bind the copper pipes , the drain pipe and the power cables together with the tape with the drain pipe at the bottom, so that water can flow freely.

- Do not remove the cap from the pipe until connecting it, to avoid dampness or dirt from entering.
- If the pipe is bent or pulled too often , it will become stiff . Do not bend the pipe more than three times at one point.
- When extending the rolled pipe, straighten the pipe by unwinding the rolled pipe, as shown in the picture.

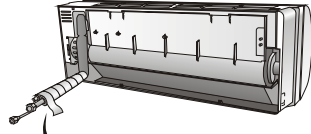
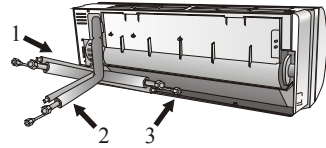

Shape the connection pipe

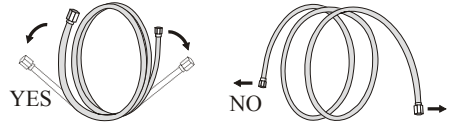

Extending the rolled pipe

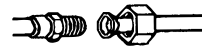

## Connections to the indoor unit

1. Remove the indoor unit pipe cap (check that there is no debris inside).
2. Insert the flare nut and create a flange at the extreme end of the connection pipe.
3. Tighten the connections by using two wrenches working in opposite directions

## Indoor unit condensed water drainage

The indoor unit condensed water drainage is fundamental for the success of the installation.

1. Place the drain hose below the piping, taking care not to create siphons.
2. The drain hose must slant downwards to aid drainage.
3. Do not bend the drain hose or leave it protruding or twisted and do not put the end of it in water . If an extension is connected to the drain hose , ensure that it is lagged when it passes into the indoor unit.
4. If the piping is installed to the right, the pipes, power cable and drain hose must be lagged and secured onto the rear of the unit with a pipe connection.
  - 1) Insert the pipe connection into the relative slot.
  - 2) Press to join the pipe connection to the base.

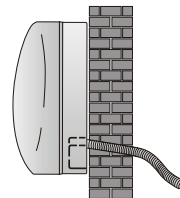

YES

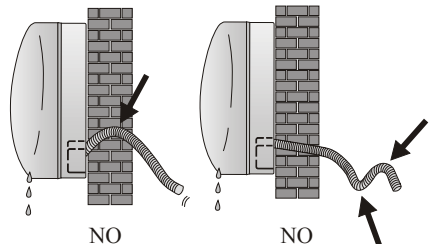

NO

NO

# INSTALLATION MANUAL---Installation of the Indoor unit

## INSTALLATION OF THE INDOOR UNIT

After having connected the pipe according to the instructions, install the connection cables. Now install the drain pipe. After connection, lag the pipe, cables and drain pipe with the insulating material.

1. Arrange the pipes ,cables and drain hose well.
2. Lag the pipe joints with insulating material , securing it with vinyl tape.
3. Run the bound pipe , Cables and drain pipe through the wall hole and mount the indoor unit onto the upper part of the mounting plate securely.
4. Press and push the lower part of the indoor unit tightly against the mounting plate

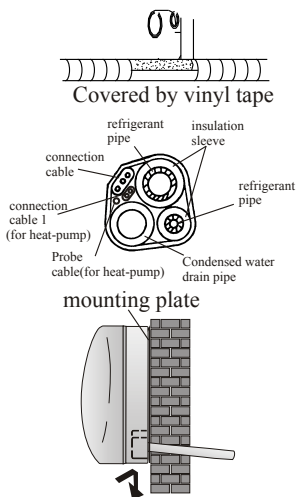

# INSTALLATION MANUAL---Installation of the outdoor unit

- The outdoor unit should be installed on a solid wall and fastened securely.
- The following procedure must be observed before connecting the pipes and connecting cables : decide which is the best position on the wall and leave enough space to be able to carry out maintenance easily.
- Fasten the support to the wall using screw anchors which are particularly suited to the type of wall;
- Use a larger quantity of screw anchors than normally required for the weight they have to bear to avoid vibration during operation and remain fastened in the same position for years without the screws becoming loose.
- The unit must be installed following the national regulations.

## Outdoor unit condensed water drainage (only for heat pump models)

The condensed water and the ice formed in the outdoor unit during heating operation can be drained away through the drain pipe

1. Fasten the drain port in the 1in. hole placed in the part of the unit as shown in the picture.
2. Connect the drain port and the drain pipe.  
Pay attention that water is drained in a suitable place.

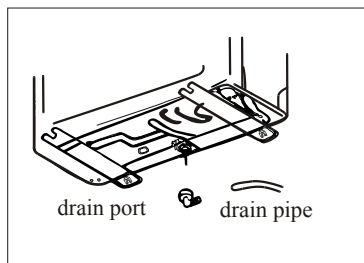

# INSTALLATION MANUAL---Installation of the outdoor unit

## ELECTRICAL CONNECTIONS

1. Remove the handle on the right side plate of outdoor unit.
2. Connect the power connection cord to the terminal board.  
Wiring should fit that of indoor unit.
3. Fix the power connection cord with wire clamp.
4. Confirm if the wire has been fixed properly.
5. An efficient earth connection must be ensured.
6. Recover the handle.

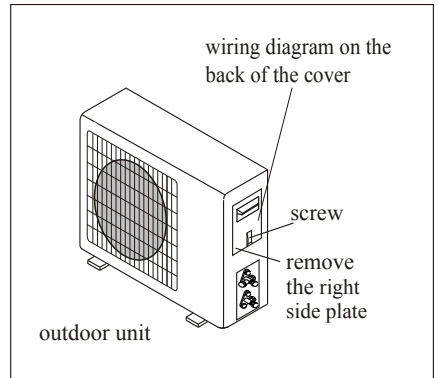

## CONNECTING THE PIPES

Screw the flare nuts to the outdoor unit coupling with the same tightening procedures described for the indoor unit.

To avoid leakage, pay attention to the following points:

1. Tighten the flare nuts using two wrenches. Pay attention not to damage the pipes.
2. If the tightening torque is not sufficient, there will probably be some leakage. With excessive tightening torque there will also be some leakage, as the flange could be damaged.
3. The surest system consists in tightening the connection by using a fix wrench and a torque wrench: Please check the torque wrench table.

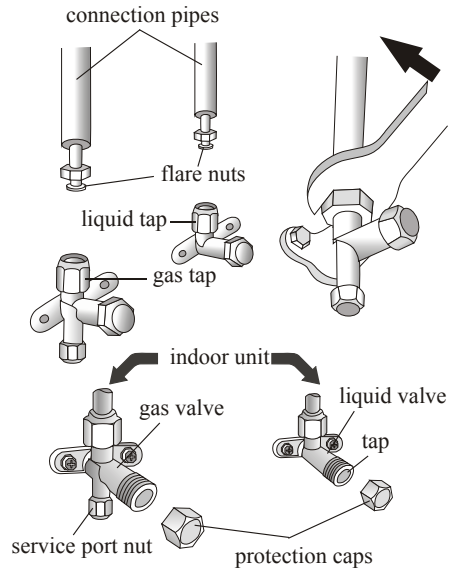

## BLEEDING

Air and humidity left inside the refrigerant circuit can cause compressor malfunction. After having connected the indoor and outdoor units, bleed the air and humidity from the refrigerant circuit by using a vacuum pump.

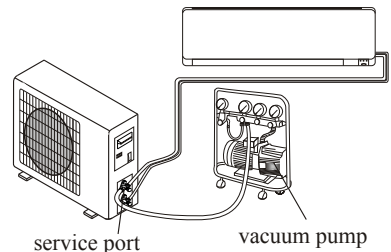

# INSTALLATION MANUAL---Installation of the outdoor unit

## BLEEDING

The air and humidity left inside the refrigerant circulation can cause compressor malfunction. After having connected the indoor and outdoor units, bleed the air and humidity from the refrigerant circulation using a vacuum pump.

- (1) Unscrew and remove the caps from the 2 - way and 3-way valves.
- (2) Unscrew and remove the cap from the service port.
- (3) Connect the vacuum pump hose to the service port.
- (4) Operate the vacuum pump for 10 - 15 minutes until an absolute vacuum of 10 mm Hg has been reached.
- (5) With the vacuum pump still in operation, close the low - pressure knob on the vacuum pump coupling. Stop the vacuum pump.
- (6) Open the 2 - way valve by 1/4 turn and then close it after 10 seconds. Check all the joints for leaks using liquid soap or an electronic leak device.
- (7) Turn the body of the 2-way and 3-way valves. Disconnect the vacuum pump hose.
- (8) Replace and tighten all the caps on the valves.

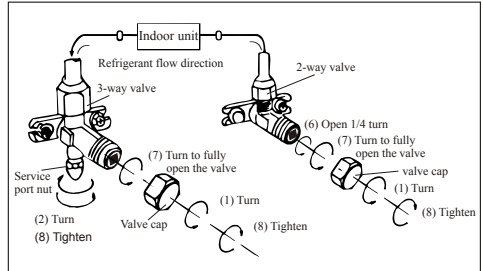
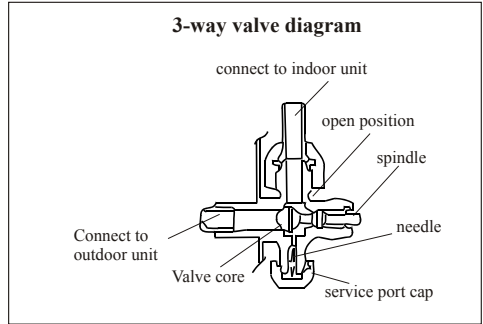

## INSTALLATION MANUAL--- operation test

1. Wind insulating covering around the joints of the indoor unit and fix it with insulating tape.
2. Fix the exceeding part of the signal cable to the piping or to the outdoor unit.
3. Fix the piping to the wall ( after having coated it with insulating tape) using clamps or insert them into plastic slots.
4. Seal the hole in the wall through which the piping is passed so that no air or water can fill.

### Indoor unit test

- Do the ON/OFF and FAN operate normally?
- Does the MODE operate normally?
- Do the set point and TIMER function properly?
- Does each lamp light normally?
- Do the flap for air flow direction operate normally?
- Is the condensed water drained regularly?

### Outdoor unit test

- Is there any abnormal noise or vibration during operation?
- Could the noise, the air flow or the condensed water drainage disturb the neighbours?
- Is there any coolant leakage?

*Note: the electronic controller allows the compressor to start only three minutes after voltage has reached the system.*

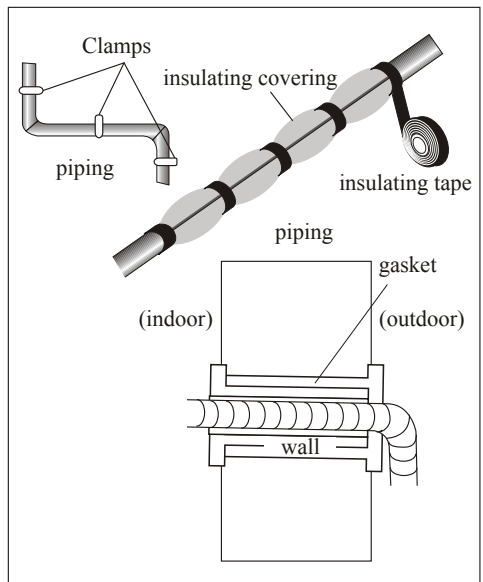



# INSTALLATION MANUAL---Information for the installer

INVERTER TYPE MODEL capacity (Btu/h)	9k	12k		15/18k	22/24k	
Liquid pipe diameter	1/4 "	1/4 "		1/4 "	1/4 "	3/8 "
Gas pipe diameter	3/8 "	3/8 "	1/2 "	1/2 "	5/8 "	
Length of pipe with standard charge	9.8ft.	9.8ft.	9.8ft.	13ft.	13ft.	
Maximum distance between indoor and outdoor unit	49.2ft.	49.2ft.	49.2ft.	49.2ft.	49.2ft.	
Additional refrigerant charge	.7oz/ft	.7oz/ft	.7oz/ft	1oz/ft	1oz/ft	
Max. diff. in level between indoor and outdoor unit	16.4ft	16.4ft	16.4ft	16.4ft	16.4ft	
Type of refrigerant(1)	R410A	R410A	R410A	R410A	R410A	

(1) Refer to the data rating label stucked on the outdoor unit.

**\*According to model's specification**

## TIGHTENING TORQUE FOR PROTECTION CAPS AND FLANGE CONNECTION

PIPE	TIGHTENING TORQUE [N x ft-lb]	CORRESPONDING STRESS (using a 7.9 in. wrench)		TIGHTENING TORQUE [N x ft-lb]
1/4 "	11.06 - 14.75	wrist strength	Service port nut	5.16 - 6.63
3/8 "	22.86 - 25.81	arm strength	Protection caps	18.43 - 22.12
1/2 "	33.19 - 36.87	arm strength		
5/8 "	44.25 - 47.94	arm strength		

## WIRING DIAGRAM

For different models, the wiring diagram may be different. Please refer to the wiring diagrams pasted on the indoor unit and outdoor unit respectively.

On indoor unit, the wiring diagram is pasted under the front panel;

On outdoor unit, the wiring diagram is pasted on the backside of the outdoor handle cover.

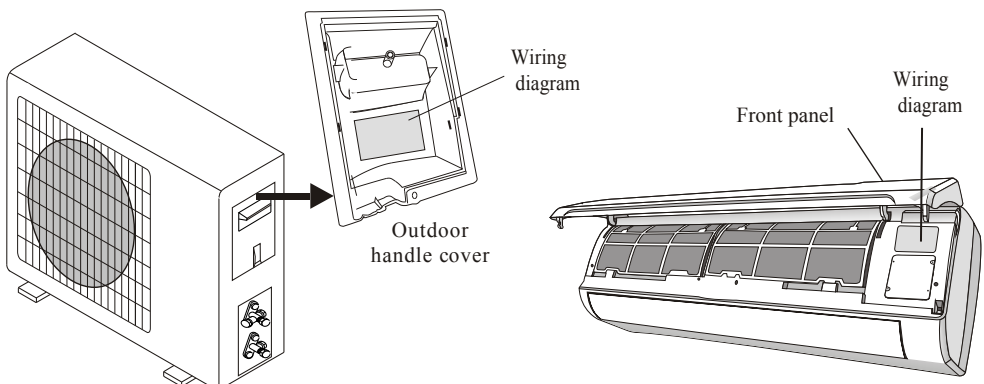

*Note: On some models the wires have been connected to the main PCB of indoor unit by manufacturer without terminal block.*

# INSTALLATION MANUAL---Information for the installer

## CABLE WIRES SPECIFICATION

MODEL capacity (Btu/h)		5k	7k	9k	12k	15/18k	22/24k	28/30k/36k
		sectional area						
Power supply cable	N	AWG18	AWG18	AWG18	AWG18 (AWG16)	AWG16	AWG14 H05RN-F	AWG12
	L	AWG18	AWG18	AWG18	AWG18 (AWG16)	AWG16	AWG14 H05RN-F	AWG12
	E	AWG18	AWG18	AWG18	AWG18 (AWG16)	AWG16	AWG14 H05RN-F	AWG12
Connection supply cable	N	.039in <sup>2</sup>	.039in <sup>2</sup>	.039in <sup>2</sup>	.039in <sup>2</sup> .059in <sup>2</sup>	.059in <sup>2</sup>	0.75mm <sup>2</sup>	0.75mm <sup>2</sup>
	L	.039in <sup>2</sup>	.039in <sup>2</sup>	.039in <sup>2</sup>	.039in <sup>2</sup> .059in <sup>2</sup>	.059in <sup>2</sup>	.029in <sup>2</sup>	.029in <sup>2</sup>
	1	.039in <sup>2</sup>	.039in <sup>2</sup>	.039in <sup>2</sup>	.039in <sup>2</sup> .059in <sup>2</sup>	.059in <sup>2</sup>	.029in <sup>2</sup>	.029in <sup>2</sup>
	2	.029in <sup>2</sup>	.029in <sup>2</sup>	.029in <sup>2</sup>	.029in <sup>2</sup>	.029in <sup>2</sup>	.029in <sup>2</sup>	.029in <sup>2</sup>
	3	.029in <sup>2</sup>	.029in <sup>2</sup>	.029in <sup>2</sup>	.029in <sup>2</sup>	.029in <sup>2</sup>	.029in <sup>2</sup>	.029in <sup>2</sup>
	⊕	.029in <sup>2</sup>	.029in <sup>2</sup>	.029in <sup>2</sup>	.029in <sup>2</sup>	.029in <sup>2</sup>	.029in <sup>2</sup>	.029in <sup>2</sup>

INVERTER TYPE MODEL capacity (Btu/h)				9k	12k	18/22k	24k	
		sectional area						
Power supply cable	N			AWG18 (AWG16)	AWG18 (AWG16)	AWG16	AWG14	
	L			AWG18 (AWG16)	AWG18 (AWG16)	AWG16	AWG14	
	E			AWG18 (AWG16)	AWG18 (AWG16)	AWG16	AWG14	
Connection supply cable	N			.039in <sup>2</sup> .059in <sup>2</sup>	.039in <sup>2</sup> .059in <sup>2</sup>	.059in <sup>2</sup>	.029in <sup>2</sup>	
	L			.039in <sup>2</sup> .059in <sup>2</sup>	.039in <sup>2</sup> .059in <sup>2</sup>	.059in <sup>2</sup>	.029in <sup>2</sup>	
	1			.039in <sup>2</sup> .059in <sup>2</sup>	.039in <sup>2</sup> .059in <sup>2</sup>	.059in <sup>2</sup>	.029in <sup>2</sup>	
	⊕			.039in <sup>2</sup> .059in <sup>2</sup>	.039in <sup>2</sup> .059in <sup>2</sup>	.059in <sup>2</sup>	.029in <sup>2</sup>	

220V 7K , 9K , 12K 15K , 16K , 18K , 22K , 24K , 30K air conditioner indoor unit fuse parameter is 50T, 3.15A  
 110V 7K , 9K 12k air conditioner indoor unit fuse parameter is 50T, 3.15A,  
 125V 7K , 9K , 12K air conditioner outdoor unit fuse parameter is 61T, 15A  
 250V 18K , 22K , 24K air conditioner outdoor unit fuse parameter is 65TS, 25A

# MAINTENANCE

Periodic maintenance is essential for keeping your air conditioner efficient.

Before carrying out any maintenance, disconnect the power supply by taking the plug out from the socket.

## INDOOR UNIT

### ANTIDUST FILTERS

1. Open the front panel following the direction of the arrow
2. Keeping the front panel raised with one hand, take out the air filter with the other hand
3. Clean the filter with water; if the filter is soiled with oil, it can be washed with warm water (not exceeding 113°F)  
Leave to dry in a cool and dry place.
4. Keeping the front panel raised with one hand, insert the air filter with the other hand
5. Close

The electrostatic and the deodorant filter (if installed) cannot be washed or regenerated and must be replaced with new filters after every 6 months.

### CLEANING THE HEAT EXCHANGER

1. Open the front panel of the unit and lift it till its greatest stroke and then unhook it from the hinges to make the cleaning easier.
2. Clean the indoor unit using a cloth with the water (not higher than 113°F) and neutral soap. Never use aggressive solvents or detergents.
3. If the outdoor unit is clogged, remove the leaves and the waste and remove the dust with air jet or a bit of water.

### END OF SEASON MAINTENANCE

1. Disconnect the automatic switch or the plug.
2. Clean and replace the filters
3. On a sunny day let the conditioner work in ventilation for some hours, so that the inside of the unit can dry completely..

### REPLACING THE BATTERIES

When:

- There is no confirmation beep heard from the indoor unit.
- The LCD doesn't act.

How:

- Take off the cover at back.
- Place the new batteries respecting the symbols + and -.

N.B: Use only new batteries. Remove the batteries from the remote controller when the conditioner is not in operation

**WARNING!** Do not throw batteries into common rubbish, they should be disposed of in the special containers situated in the collection points.

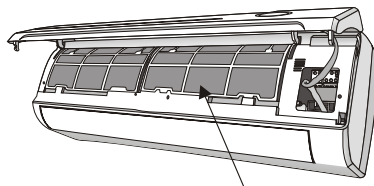
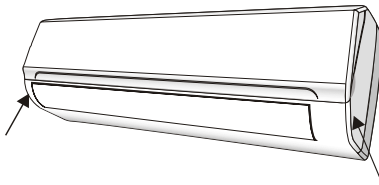

antidust filter

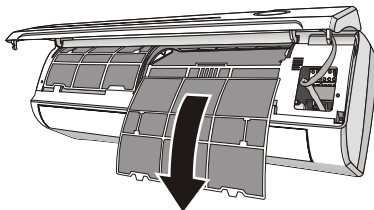

# TROUBLESHOOTING

MALFUNCTION	POSSIBLE CAUSES
The appliance does not operate	Power failure/plug pulled out
	Damaged indoor/outdoor unit fan motor
	Faulty compressor thermomagnetic circuit breaker
	Faulty protective device or fuses.
	Loose connections or plug pulled out
	It sometimes stops operating to protect the appliance.
	Voltage higher or lower than the voltage range
	Active TIMER-ON function
Strange odour	Damaged electronic control board
Strange odour	Air filter dirty
Noise of running water	Back flow of liquid in the refrigerant circulation
A fine mist comes from the air outlet	This occurs when the air in the room becomes very cold, for example in the “COOLING” or “DEHUMIDIFYING/DRY” modes.
A strange noise can be heard	This noise is made by the expansion or contraction of the front panel due to variations in temperature and does not indicate a problem.
Insufficient airflow, either hot or cold	Inappropriate temperature setting..
	Air inlet or outlet of indoor or outdoor unit has been blocked.
	Air filter is blocked.
	Fan speed set at minimum.
	Other sources of heat in the room.
The appliance does not respond to commands	No refrigerant.
	Remote control is not near enough to indoor unit.
	Battery in Remote controller may have been exhausted..
The display is off	Obstacles between remote control and signal receiver in indoor unit.
	Active LED function
	Power failure

## Switch off the air conditioner immediately and cut off the power supply in the event of:

- Strange noises during operation.
- Faulty electronic control board
- Faulty fuses or switches.
- Spraying water or objects inside the appliance.
- Overheated cables or plugs.
- Very strong smells coming from the appliance.

## ERROR SIGNALS ON THE DISPLAY

In case of error, the display on the indoor unit shown the following error codes:

	RUN lamp	Description of the trouble
<i>E1</i>	flashes once	The fault of indoor temperature sensor
<i>E2</i>	flashes twice	The fault of indoor pipe temperature sensor
<i>E6</i>	flashes 6 times	Malfunction of indoor fan motor.

# WARRANTY

**Limited Warranty provided by Comfortside, LLC. (hereby referred to as Comfortside) applies only to registered products installed by a licensed HVAC technician and covers specified products and parts, subject to the following details:**

**Product Registration:** Products must be registered for Limited Warranty within 60 days of installation by licensed HVAC technician. Products can be registered at [bravominisplits.com](http://bravominisplits.com). Alternatively, the warranty registration card from the product User's Manual can be filled out and sent in as instructed.

**Warranty Coverage:** The warranty covers the parts of the products which may be defective due to the quality of the materials or workmanship, under normal use and proper maintenance. Warranty is provided only to the first original owner of the Product, where it is originally installed, and is not transferable to the subsequent owners.

**Warranty Exclusions:** Comfortside is not responsible for any warranty claim:

1. For equipment installed outside of North America.
2. For equipment not installed according to manufacturer's guidelines.
3. For equipment which has been removed from the original site of installation and reinstalled at another location.
4. If registration information cannot be verified (i.e., invalid license number or wrong information provided).
5. Regarding damages or repairs arising as a result of a faulty installation, inappropriate application, or improper use.
6. Regarding damages or repairs arising from any external perils, out of Comfortside's control, acts of nature such as fires, storms, accidents, floods, broken or frozen water pipes, electrical surges, input power with under or overvoltage, lightning, or existence of corrosive substances nearby.
7. Regarding damages or repairs arising from use of non-compatible parts, third-party components, alterations, modifications, or improper applications.
8. Regarding improper service or poor maintenance of the equipment, such as cleaning of all air filters, heat exchangers, fans, and blowers, in addition to any necessary lubrication of internal components and maintenance of external accessories.
9. Regarding changes that can be considered cosmetic, including but not limited to small fin damages, scratches on the unit cover, etc.
10. Regarding resetting of power or the circuit breakers and replacement of other types of fuses, both internal and external.
11. Regarding any damage caused using dirty, recycled, or wrong type of refrigerants and lubricants.
12. Regarding damage due to moisture, air, dust, sand, dirt, etc., that have been allowed into the system.
13. Regarding damage caused by continuing use of the product after a malfunction has been noticed or indicated at the display module, through an error code.
14. Regarding damages or performance issues due to improper matching, product selection, under-sizing, over-sizing, improper installation, or misuse.
15. Regarding loss or replacement of refrigerant, lubricant, or oil.
16. Regarding labor or any costs associated with labor.

**Warranty Begin Date:** Warranty begins on the date of registration.

**Warranty End Date:** Products that have not been registered as instructed above are not covered under Warranty. The length of your Warranty depends on the specific model unit you have purchased. Information on Warranty length is available online, by visiting [bravominisplits.com](http://bravominisplits.com). As further explained below in detail, coverage is only for the original registered user who owns and resides in the dwelling or operates business in the property in which the product is installed.

# WARRANTY

**Remaining Warranty:** Any part, component or product that is replaced under the terms of the Warranty, will be covered under the same Warranty for the duration in which the original Warranty for the product is applicable.

**Warranty Procedure:** Comfortside will furnish a new or refurbished part, without any charge for the part itself, for the replacement of any part that has been determined to have failed, by Comfortside at its sole discretion, due to defects in its materials or workmanship under standard use and proper maintenance. The payment of the shipping costs for the part will be the sole responsibility of the owner of the product. Comfortside reserves the right to ask the owner of the product to return the failed part before or after a replacement part is sent out. The product owner or technician should contact Comfortside Technical Support at (786) 953-6706, Monday to Friday from 9AM to 5PM Eastern Time, while the technician is on site, servicing the unit. The product may or may not display error codes. The technician should be on site while troubleshooting with the Comfortside Technical Support Agent so he or she can address symptoms observed, specific electrical and mechanical measurements, and other detailed information that may be required for proper diagnosis.

While technicians may refer to Comfortside's website or YouTube channel for helpful information, such as manuals and videos based on certain error codes, the technician will need to troubleshoot with the Technical Support Agent for Warranty purposes. Comfortside is not able to remotely diagnose a product and or offer remedies, without proper diagnosis results.

When contacting Technical Support, a licensed technician must be onsite, and the following information needs to be provided:

- The Serial Number of the unit.
- The product purchase invoice and an installation invoice from licensed HVAC technician.
- Case number (if applicable) provided during previous Technical Support call(s).
- Comfortside may ask for photos and/or other diagnostic information it deems necessary prior to processing the Warranty claim.

It should be noted that Comfortside Technical Support Agents troubleshoot on a case-by-case basis, following best practices and procedures to diagnose problems and solutions. Through this process, it is most efficient to diagnose one issue or error code at a time. It is possible that the first suggested solution may or may not solve one problem of multiple failures, in which case the Technician will continue through troubleshooting for remaining issues/error codes.

**Labor cost, materials, and other costs:** Any labor costs and/or the costs for the supplies or materials used or purchased in the field for the replacement of the defective part, remain the responsibility of the owner. No other costs involved in diagnosis, lodging, transportation, servicing, repair, replacement, installation, removal, shipping, etc., are to be covered under the Warranty.

**Refrigerant:** Any costs related to charging, recharging, adjustment, or removal of refrigerant, and the cost of the refrigerant itself, are not covered under any circumstances. All products go through vigorous quality

Comfortside does not cover any claims related to the lack of refrigerant in new products, discovered upon arrival, or during installation, as well as subsequent refrigerant loss occurring at any time afterward.

# WARRANTY

This Warranty is not transferable. No person or entity is authorized to change the terms and conditions outlined in this Warranty agreement, in any respect, nor to create any additional obligations or liabilities for any party involved.

This warranty agreement supersedes all prior warranty agreements between the parties and constitutes the complete, final, and exclusive understanding of the parties with respect to the subject matter. All prior negotiations, representations, or promises, whether oral or written, of either party shall be deemed to have been merged herein.

If any part of this Warranty Agreement shall be invalidated for any reason, such part shall be deleted, and the remainder shall be unaffected and shall continue in full force and effect. This Warranty provides you certain legal rights and you may also have other rights, which vary from State to State. Therefore, some of these limitations or exclusions may not apply to you.

**States with Express and Implied Warranties:** Products in states with Express and Implied Warranties do not need to be registered for Comfortside Warranty. However, for Warranty support, installation invoice should be provided.

## **Pursuing legal remedies:**

**ARBITRATION CLAUSE. IMPORTANT. PLEASE REVIEW THIS ARBITRATION CLAUSE, AS IT AFFECTS YOUR LEGAL RIGHTS.**

1. This arbitration clause affects your rights against Comfortside and any of its employees, agents, affiliates, successors, or assignees, all of whom together are referred to below as “we” or “us” for the simplicity of reference.
2. **ARBITRATION REQUIREMENT; EXCEPT AS STATED BELOW, ANY DISPUTE BETWEEN YOU AND ANY OF US SHALL BE DECIDED BY NEUTRAL AND BINDING ARBITRATION, RATHER THAN ANY COURT OR BY TRIAL BY JURY. ARBITRATION WILL BE HANDLED ONLY ON AN INDIVIDUAL BASIS AND ALL PARTIES EXPRESSLY WAIVE; ANY RIGHTS TO PARTICIPATE AS A CLASS REPRESENTATIVE OR CLASS MEMBER, ANY RIGHTS TO CLASS ARBITRATION OR ANY CONSOLIDATION OF INDIVIDUAL ARBITRATIONS. THE ARBITRATOR WILL BE A MEMBER OF THE AMERICAN ARBITRATION ORGANIZATION.** The meaning of “Dispute” has the broadest possible meaning allowable by law, including any controversy, claim or other dispute, relating to or arising from the purchase of the product, any of the warranties upon the product, or the condition of the product, as well as the determination of the application or the scope of the Arbitration Clause itself. Rights to appeal and discovery are also limited in arbitration based on the rules of the arbitration organizations.
3. **Governing Law:** Effect and procedures of arbitration will be governed by the Federal Arbitration Act (9 U.S.C. § et seq.) rather than any related state law. In case of any substantive warranty, your claims and rights under such substantive warranty will be governed by the applicable law of the state in which Product was purchased.
4. **Location of the Arbitration:** Unless otherwise provided under the applicable law, arbitration hearing will be conducted in the judicial district in Miami-Dade County, Florida.
5. **Costs of the Arbitration:** Unless otherwise provided under the applicable law, each party will be responsible for its own cost, payable to the arbitration organization, and the costs of their attorneys, experts or other fees.
6. **Survival and Enforceability of the Arbitration Clause:** This arbitration clause will survive the expiration or termination of this warranty agreement, indefinitely.

**Bravo**  
MORE THAN A COMPLIMENT